

10W DALI/Push+Triac+0/1-10V LED Driver

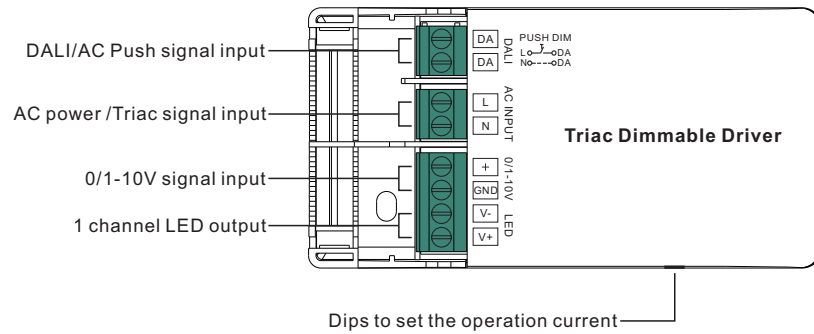

Important: Read All Instructions Prior to Installation

Function introduction



Product Data

Output	LED Channel	1			
	Selectable Current	200mA	250mA	300mA	350mA
	DC Voltage Range	6-42V	6-40V	6-33V	6-28V
	Current Accuracy	±3%			
	Rated Power	10W max.			
Input	Voltage Range	220-240V AC			
	Frequency	50/60Hz			
	Power Factor (Typ.)	> 0.9			
	Efficiency (Typ.)	> 80% @ 230VAC			
	Input Current	55mA @ 230VAC			
	Inrush Current (Typ.)	COLD START Max. 2A @ 230VAC			
Control	Dimming Interface	DALI/Push+Triac+0/1-10V			
	Dimming Range	1%-100%			
	Dimming Method	Amplitude dimming (No output PWM)			
Protection	Short Circuit	Yes, auto recovery after fault removed			
	Over Current	Yes, auto recovery after fault removed			
	Over Temperature	Yes, auto recovery after fault removed			

Environment	Working Temp.	-20°C ~ +45°C
	Max. Case Temp.	85°C
	Working Humidity	10% ~ 95% RH non-condensing
	Storage Temp. & Humidity	-40°C ~ +80°C, 10% ~ 95% RH
Safety&EMC	Safety Standards	EN61347-1, EN61347-2-13
	Withstand Voltage	I/P-O/P: 3.75KVAC
	EMC Emission	EN55015, EN61000-3-2, EN61000-3-3
Others	EMC Immunity	EN61547, EN61000-4-2,3,4,5,6,8,11, surge immunity Line-Line 0.5KV
	MTBF	193.6K hrs min. @ 230VAC at full load and 25°C ambient temperature
	Dimension	103.7*52.6*30mm (L*W*H)

- Dimmable LED driver with DALI/Push+Triac+0/1-10V dimming interfaces
- 1 channel constant current output, max. output power 10W
- Output current 200mA-350mA selectable by DIP switch
- Enables to control single color LED lighting
- Class II power supply, full isolated plastic case
- High power factor and efficiency
- Complies to IEC 62386-101, IEC 62386-102, IEC 62386-207
- Compatible with universal DALI masters that support DT6 commands
- Compatible with universal Triac dimmers
- Compatible with universal 0/1-10V dimmers
- Analog current control, no PWM output, flicker free
- IP20 rating, suitable for indoor LED lighting applications

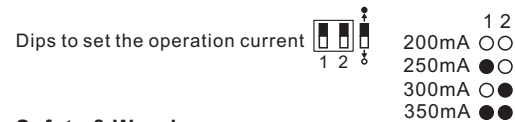

Safety & Warnings

- DO NOT install with power applied to device.
- DO NOT set the operation current with power applied
- DO NOT expose the device to moisture.

Operation

1. Dimming Interface Selection

- 1.1. The LED driver supports 4 kinds of dimming input: DALI, Push, Triac, 0/1-10V.
- 1.2. Please select any of the 4 dimming interfaces to wire each time.
- 1.3. To connect a new dimming interface, previously connected dimming interface must be disconnected.
- 1.4. DO NOT connect more than 2 (including 2) dimming interfaces simultaneously.

2. DALI Address Assigned by DALI Masters

While connected with DALI interface, 1 DALI address can be assigned by DALI Master controller automatically, please refer to user manuals of compatible DALI Masters for specific operations.

3. PUSH Dimmer Mode

While connected with a AC PUSH, the driver will be in Push Dimmer Mode, operations under Push Dimmer Mode are as follows:

- 3.1. Click the button to switch ON/OFF
- 3.2. Press and hold down the button to increase or decrease light intensity to desired level and release it, then repeat the operation to adjust light intensity to opposite direction. The dimming range is from 1% to 100%.
- 3.3. Memory function after power off or power failure enables the device to memorize the status before power off while power on again.

4. Triac Dimming Input

While connected with a Triac dimmer, different Triac dimmers from different suppliers may have different minimum dimming levels which the driver can not be dimmed below. To dim to 1%, please make sure the dimmer supports 1% minimum dimming level.

Wiring Diagram

1. With DALI bus

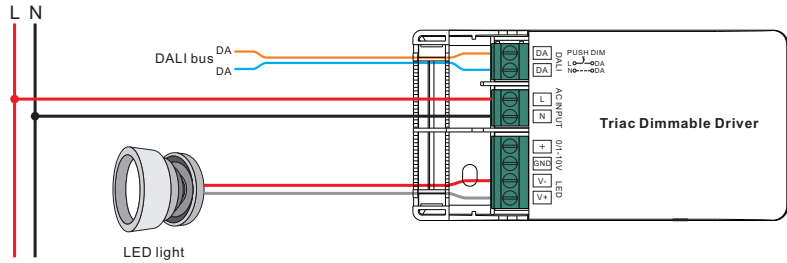

2. With PUSH dimmer

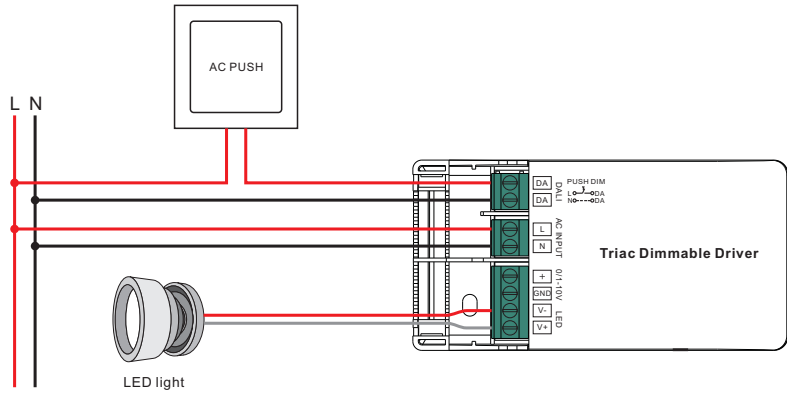

3. With Triac dimmer

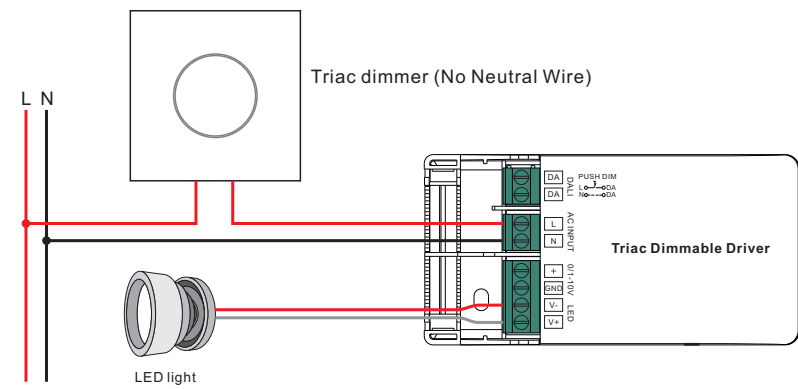
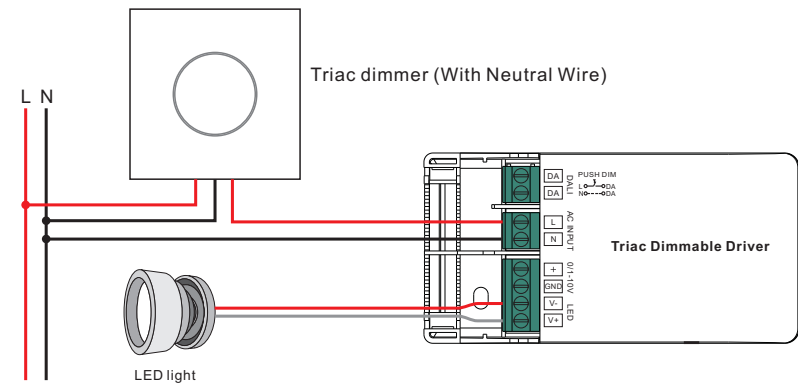

4. With 0/1-10V dimmer

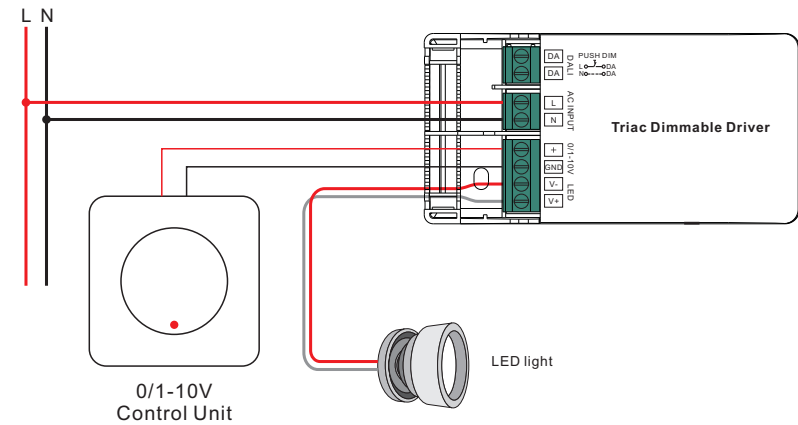

Product Dimension

