

# 50W Triac+DALI/Push+0/1-10V Dimmable mA Led Driver

(Driver-TRIAC-mA-50W)



**Important:** Read All Instructions Prior to Installation

## Function introduction

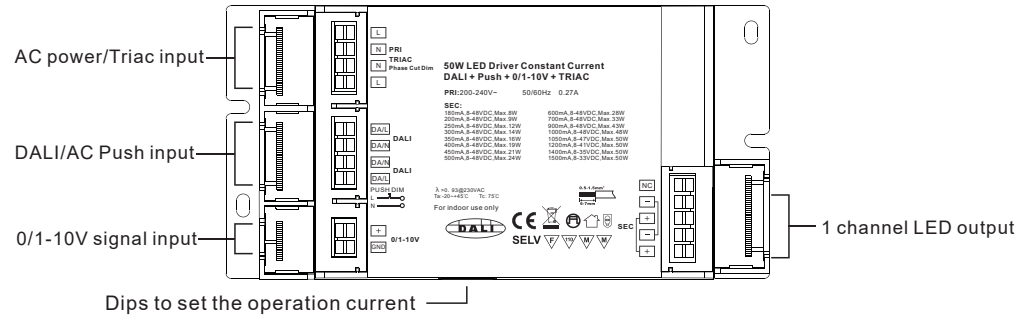

## Product Data

	LED Channel	1							
	Output	Selectable Current	180mA	200mA	250mA	300mA	350mA	400mA	450mA
	DC Voltage Range	8-48V	8-48V	8-48V	8-48V	8-48V	8-48V	8-48V	8-48V
	Selectable Current	600mA	700mA	900mA	1000mA	1050mA	1200mA	1400mA	1500mA
	DC Voltage Range	8-48V	8-48V	8-48V	8-48V	8-47V	8-41V	8-35V	8-33V
	Current Accuracy	±3%							
	Rated Power	50W							
Input	Voltage Range	200-240V AC							
	Frequency	50/60Hz							
	Power Factor (Typ.)	> 0.9							
	Efficiency (Typ.)	> 87% @ 230VAC							
	Input Current	0.27A @ 230VAC							
	Inrush Current (Typ.)	COLD START Max. 2A @ 230VAC							
Control	Dimming Interface	Triac+DALI (DALI consumption < 2mA)/Push+0/1-10V							
	Dimming Range	1%-100%							
	Dimming Method	Pulse Width Modulation							
Protection	Short Circuit	Yes, auto recovery after fault removed							
	Over Current	Yes, auto recovery after fault removed							
	Over Temperature	Yes, auto recovery after fault removed							

Environment	Working Temp.	-20°C ~ +45°C
	Max. Case Temp.	75°C (Ta=+45°C)
	Working Humidity	10% ~ 95% RH non-condensing
	Storage Temp. & Humidity	-40°C ~ +80°C, 10% ~ 95% RH
Safety&EMC	Safety Standards	EN61347-1, EN61347-2-13
	Withstand Voltage	I/P-O/P: 3.75KVAC
	EMC Emission	EN55015, EN61000-3-2, EN61000-3-3
	EMC Immunity	EN61547, EN61000-4-2,3,4,5,6,8,11, surge immunity Line-Line 1KV
Others	MTBF	192800H, MIL-HDBK-217F @ 230VAC at full load and 25°C ambient temperature
	Dimension	164.6*83*34.5mm (L*W*H)

## Output Current

Select the correct output current before wiring to LED light by DIP Switches. Please make sure the power to the driver is disconnected before selection of the output current.

## Dips to set the voltage and operation current

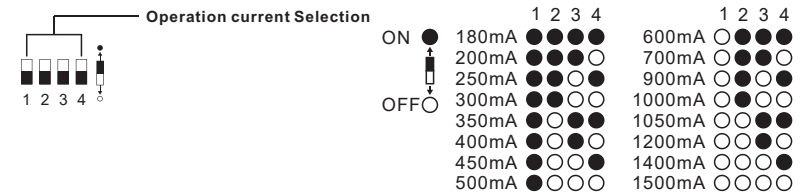

- Dimmable LED driver with Triac+DALI/Push+0/1-10V dimming interfaces 4 in 1
- 1 channel constant current output, max. output power 50W
- Output current 180mA-1500mA selectable by DIP switch
- Enables to control single color LED lighting
- Class II power supply, full isolated plastic case
- High power factor and efficiency
- Complies to IEC 62386-101, IEC 62386-102, IEC 62386-207
- Compatible with universal DALI masters that support DT6 commands
- Compatible with universal Triac dimmers
- Compatible with universal 0/1-10V dimmers
- IP20 rating, suitable for indoor LED lighting applications
- 5 years warranty

## Safety & Warnings

- DO NOT install with power applied to device.
- DO NOT set the operation current with power applied
- DO NOT expose the device to moisture.

## Operation

### 1. Dimming Interface Selection

- 1.1. The LED driver supports 4 kinds of dimming input: DALI, Push, Triac, 0/1-10V.
- 1.2. Please select any of the 4 dimming interfaces to wire each time.
- 1.3. To connect a new dimming interface, previously connected dimming interface must be disconnected.
- 1.4. DO NOT connect more than 2 (including 2) dimming interfaces simultaneously.

### 2. DALI Address Assigned by DALI Masters

While connected with DALI interface, 1 DALI address can be assigned by DALI Master controller automatically, please refer to user manuals of compatible DALI Masters for specific operations.

### 3. PUSH Dimmer Mode

While connected with a AC PUSH, the driver will be in Push Dimmer Mode, operations under Push Dimmer Mode are as follows:

- 3.1. Click the button to switch ON/OFF
- 3.2. Press and hold down the button to increase or decrease light intensity to desired level and release it, then repeat the operation to adjust light intensity to opposite direction. The dimming range is from 1% to 100%.
- 3.3. Memory function after power off or power failure enables the device to memorize the status before power off while power on again.

### 4. Triac Dimming Input

While connected with a Triac dimmer, different Triac dimmers from different suppliers may have different minimum dimming levels which the driver can not be dimmed below. To dim to 1%, please make sure the dimmer supports 1% minimum dimming level.

### Wiring Diagram

#### 1. With Triac dimmer

##### 1.1 One Triac Dimmer to Control Single Driver

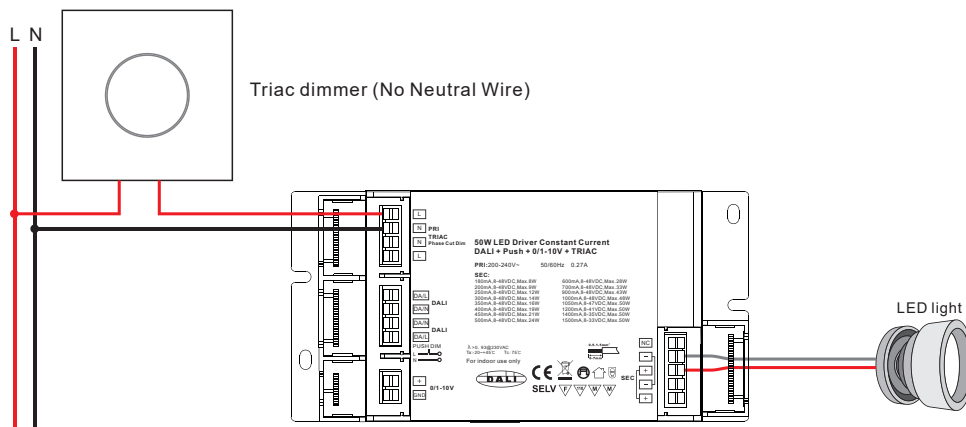
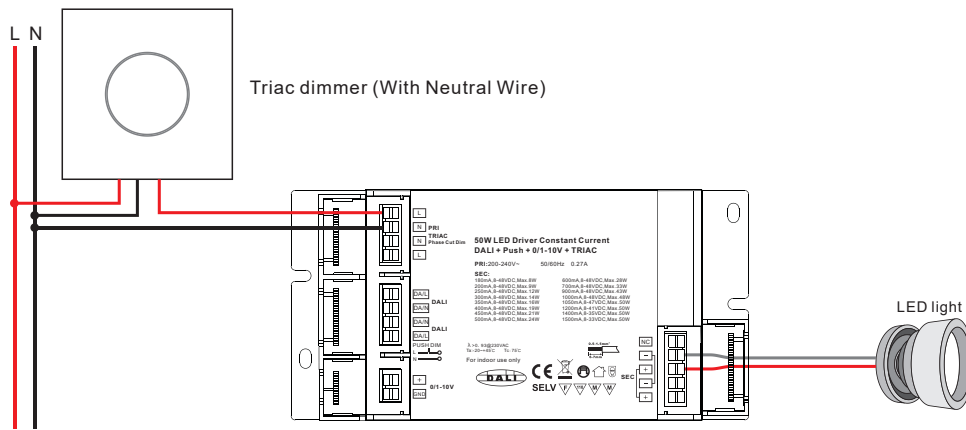

##### 1.2 One Triac Dimmer to Control Multiple Drivers Simultaneously

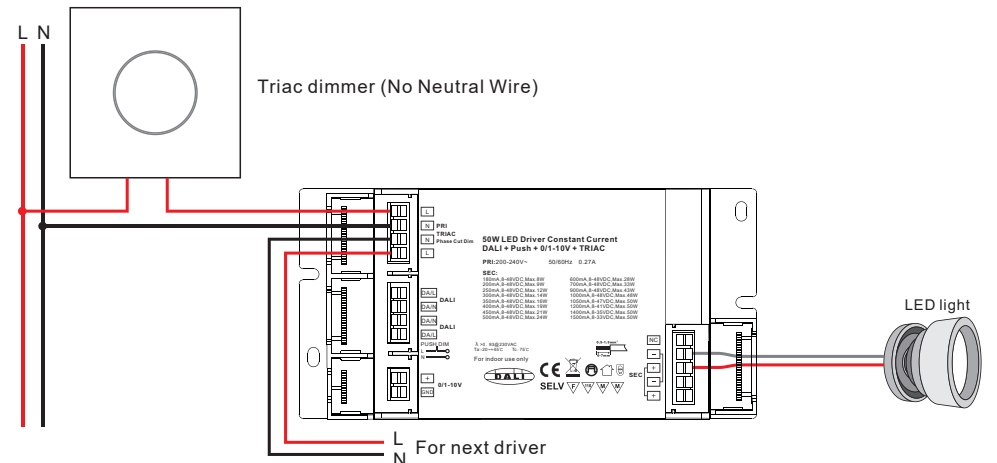
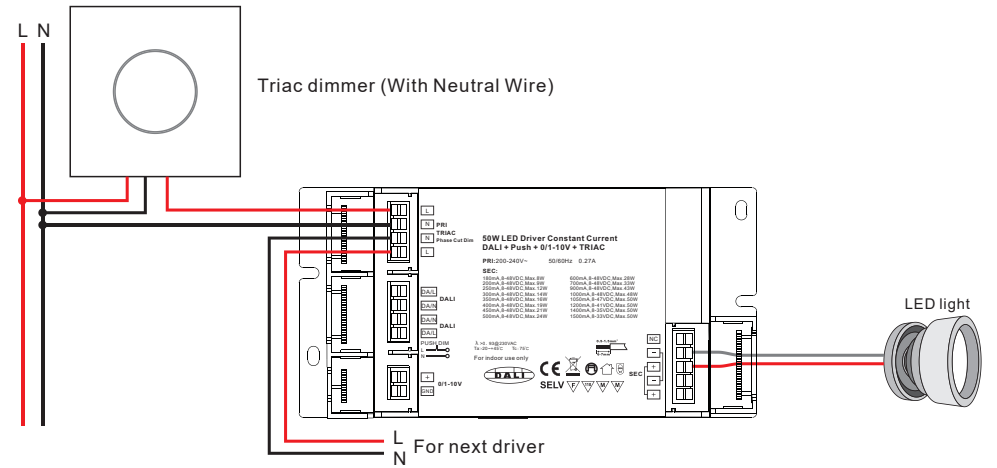

#### 2. With DALI bus

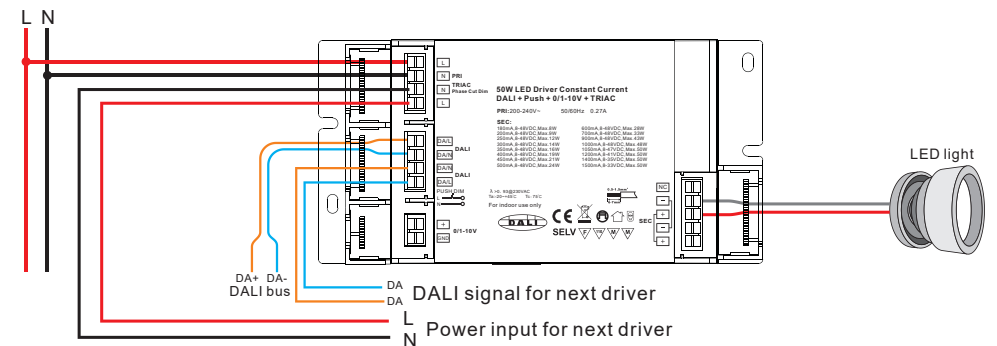

### 3. With PUSH Switch

#### 3.1 One Push Switch to Control Single Driver

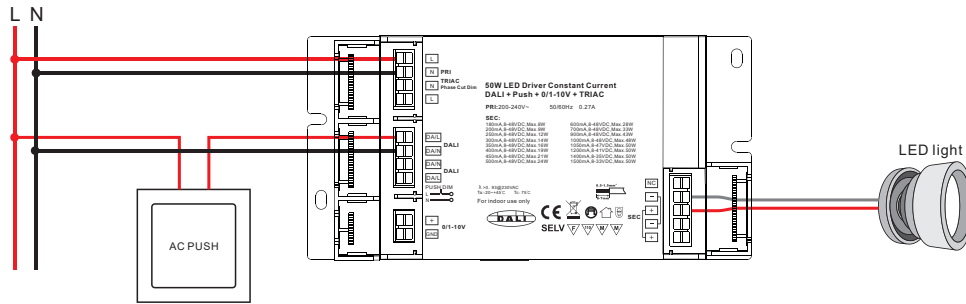

### Product Dimension

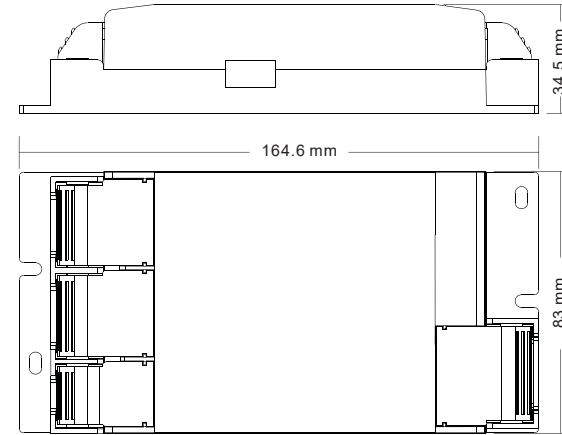

#### 3.2 One Push Switch to Control Multiple Drivers Simultaneously

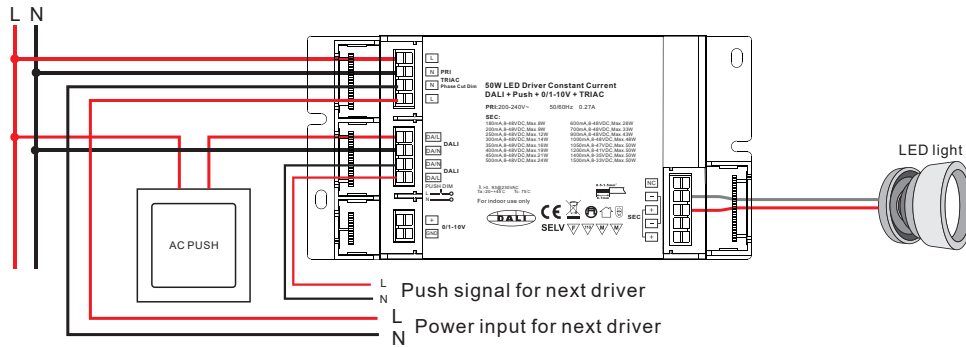

### 4. With 0/1-10V dimmer

